

我们的使命  
Our mission

普及自动吊挂系统  
Universal automatic UPS system

全球缝制流水专家  
The global Sewing experts



010100101010101010101010

010100101010101010101010

0101001010101010

**Euratex**<sup>®</sup>  
**speed** 欧泰科

服装智造 智胜之道  
A smart way of apparel manufacturing



010100101010101010101010

010100101010101010101010

0101001010101010



秉承三十年北美智能服装生产系统经验  
全球首家双轨服装吊挂系统

World's first double-rail Garment UPS (Unit Production System)



010100101010101010101010

010100101010101010101010

0101001010101010



010100101010101010101010

010100101010101010101010

0101001010101010

**Euratex**<sup>®</sup>  
**speed** 欧泰科

上海欧泰科智能科技有限公司  
Shanghai Euratex System Technologies Inc.

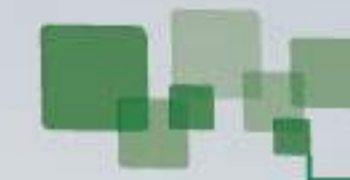

## 我们是谁 Who are we

### • 欧泰科公司简介 Euralex company controbution

上海欧泰科智能科技有限公司秉承加拿大Euralex Canada Inc.数十年的数字化设备技术及经验,是全球最早生产服装数字化设备的制造商之一。是加拿大派特系统(PAD System Technologies)及美国图圣公司(Tukatech)最主要的硬件合作伙伴。多年来,公司生产的绘图仪、切割机受到广大服装企业用户的依赖与认可。

Euralex® 欧泰科®自问世以来,凭借强大的产品研发能力,相继推出了服装CAD/CAM/ERP系统。通过高科技手段,有效、简便、快捷地服务于服装、纺织、机械等企业的生产与管理。2005年公司推出了Euralex® 欧泰科®全自动智能吊挂系统,2012年公司推出了Euralex® 欧泰科®全自动智能仓储系统,有效的提高了服装企业的生产效率及竞争力,为企业带来更大的利润空间。

Euralex® 欧泰科®经过多年的经营与发展,为企业完善、系统的教学培训,一流的技术支持及售后服务。帮助服装企业实现整体信息化是Euralex® 欧泰科®的追求目标。

Euralex® 欧泰科®形成了品牌下的完整的CAD/CAM/ERP产品系列。公司相继开发了服装企业管理系统、计算机辅助设计系统、绘图仪、切割机、服装生产智能吊挂系统,产品广泛应用于服装、鞋业、家纺、箱包、汽车等行业。

Euralex® 欧泰科®的宗旨是“我们在意销售多少产品,我们更在意拥有多少满意的客户”。与国际接轨,使中国的服装企业迅速了解和采用国外的先进技术,更好地服务于中国的服装企业是Euralex® 欧泰科®的追求。

Shanghai Euralex® System Technologies Inc,one of the earliest garment CAD/CAM/ERP of Canada PAD System Technologies Inc. and Tukatech System USA.

A garment CAD/CAM/ERP of Euralex® systems Technologies provides more effective,convenient and on time service in garment manufacturing and management.Euralex® smart UPS (Unit Production System)have effectively improved garment manufacturing efficiency and competence.

After years deveiopment, Euralex® has provides enterprises perfect service and training. Euralex® aims to help garment enterprises realize the digitizing and Rapid Manufacturing.

Euralex® CAD/CAM/ERP series products under Euralex® brand include Euralex® CAD system/plotter/cutting machine/smart UPS/smart WMS(warehouse manage system)were windely used in garment,footwear,home textile,luggage and automobile manufacturing.

“We care how many products we sale.We care more how many satisfied customers we have.”

# GOAL



**06** 我们的售后服务  
Our after-sales service

**07** 我们的客户  
Our customers

**08** 我们的荣誉  
Our Honors



**02** 我们生产什么  
What do we make

欧泰科全自动制衣吊挂系统介绍  
Euralex automatic garment UPS system

世界独家双轨服装智能吊挂系统  
Double rail smart UPS(Unit Production System)

单轨智能服装吊挂系统  
Monorail smart UPS(Unit Production System)

链式智能服装吊挂系统  
Chain smart UPS(Unit Production System)

服装悬挂仓储系统介绍  
Garment hanging storage system



**03** 我们的优势与特点  
Our advantages and features

**04** 我们的产品研发  
Our product research and development

**05** 我们的培训  
Our training



**01** 我们是谁  
Who we are

欧泰科公司简介  
Company controbution

我们的实力  
Our strength

欧泰科量身打造生产流程  
Made-to-order Adaptable Production Process



• 我们的实力  
Our Capacity

欧泰科®，全球最大的服装吊挂系统生产研发基地

Euratex® ,The largest research, development and production base of UPS system in the world



江苏淮安生产基地  
Jiangsu Huai'an Production Base



占地45亩，  
年生产能力：100000站

Covering 45 mu (3 hectares)  
Annual Output: 100,000 stations

中国上海总部  
Headquarters in Shanghai, China



占地15000平方米，  
年生产能力：100000站

Covering 15,000 square meters  
Annual Output: 100,000 stations

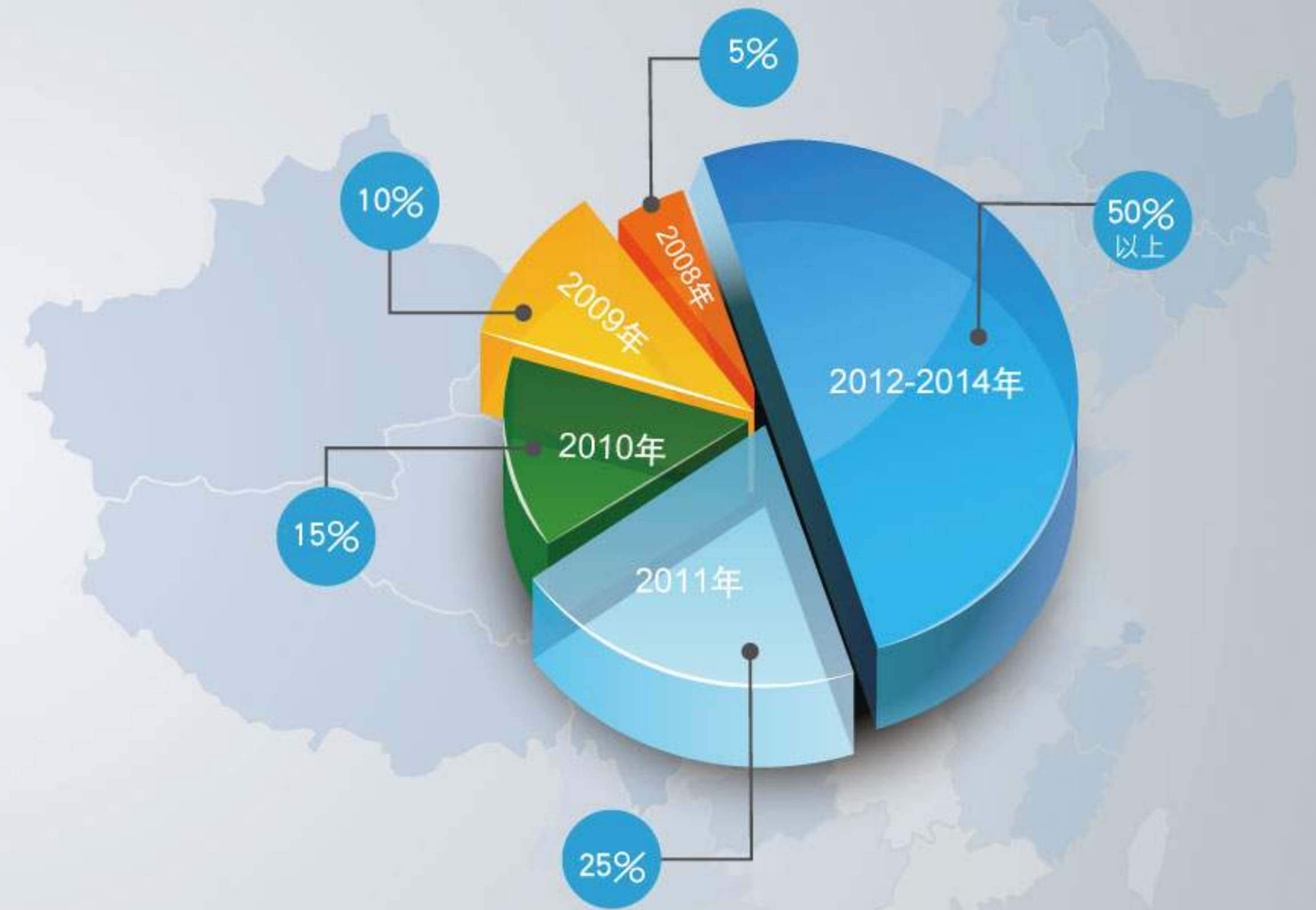
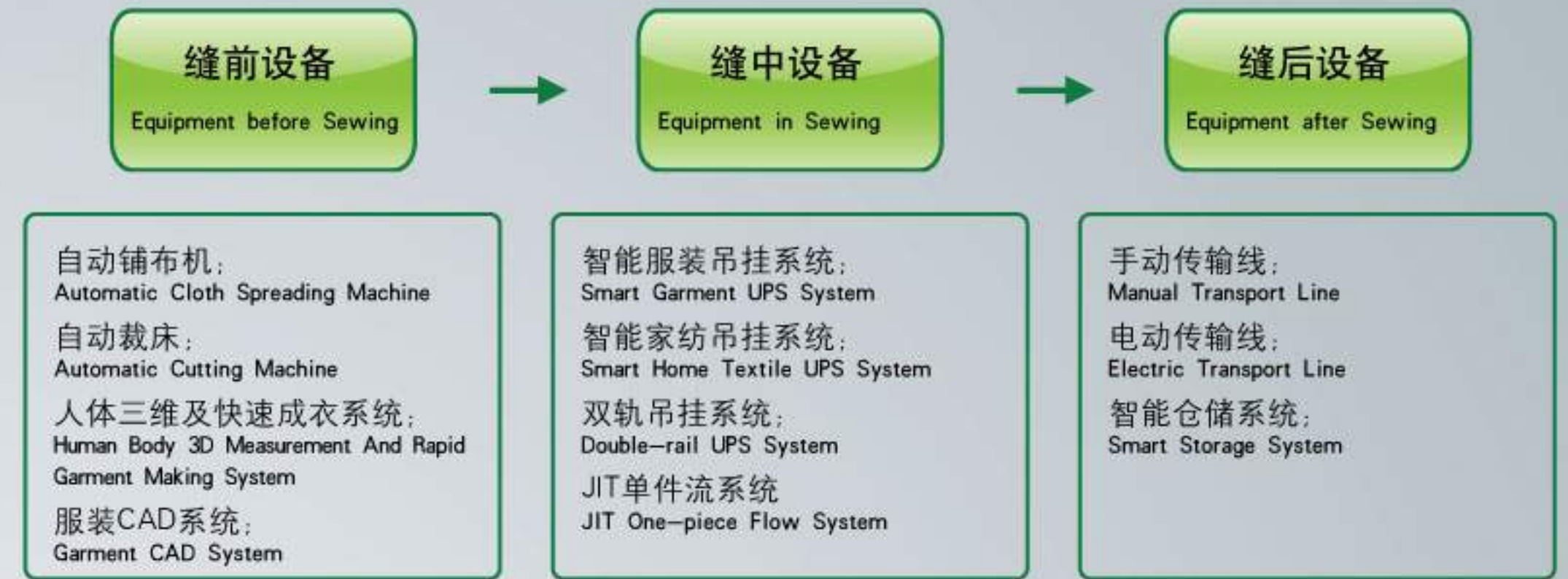

欧泰科正在快速发展阶段

Euratex® is experiencing rapid development

我们每年以100%的业务速度，2014年，吊挂将占领市场的65%。未来几年，欧泰科将完成上市的目标。我们有覆盖全国各地的经销服务能力，已建立多家4S服务中心。

Our business expands 100% per year, In 2014, the market share is near 65%. In the next few years, Euratex will realize the target—listed company. In the following few years, our services center covers all over the country, lots of 4S service centers.

• 欧泰科量身打造生产流程  
Made-to-order Adaptable Production Process

STEP 1



**系统控制站 System Control Station**  
全部生产过程通过计算机设定、控制、管理。可满足不同班制及多款式同时上线生产  
All production process is computer-designed, controlled and managed, which ensures multi-shift operation and simultaneous production of several styles.

STEP 2



**挂衣工序站 Loading Station**  
将生产一件衣服所需要的全部裁片及部件挂在一个衣架上  
All cut pieces and articles for one garment are on one hanger.

STEP 3



**车缝工序站 Sewing Station**  
员工减少了辅助工时,只进行缝制操作,提高生产效率  
With the time for auxiliary work much reduced, the operators can concentrate on sewing to improve the work efficiency.

STEP 7



**检测、卸衣站 QC & UL station**  
成品的检测、下线  
Inspection and unloading of finished products.

STEP 5



**质量控制站 QC Station**  
通过衣架、跟踪、控制员工生产量,对整个生产过程的工艺、品质及操作人员进行全自动监控、管理  
The whole production process, product quality and performance of the operators are automatically controlled and managed.

STEP 4



**样品抽检 Sample Inspection**  
随时抽样检验,任何不合格产品均可通过衣架内的电子芯片记录返回到相应的生产工序  
Random inspection guarantees that any non-standard product is returned to the relevant process according to the record on the chip of each hanger.

STEP 6



**整烫工作站 Ironing Station**  
将整烫工作放入吊挂生产线中,提高了生产效率及产品质量  
Ironing is made part of UPS (Unit Production System) so that work efficiency and product quality are much improved.

Euratex® 欧泰科®吊挂系统的优点

- 集多年生产经验之软件设计
- 随机抽取管理
- 分段式工序生产
- 同一工序站可同时生产多种款式
- 网络安排生产工序
- 多条件生产系统链接式生产
- 生产系统可把服装运输到不同的楼层
- 自动平衡生产流程
- 提供客户线上即可品质报告

节省管理人员工作时间  
Easy to handle

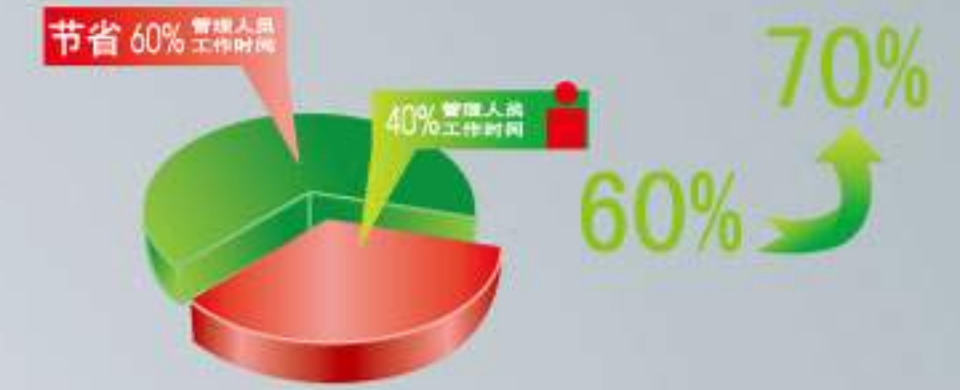

Advantages of EuratexUPS(Unit Production System)

- Design of software based on years' experience
- Random sampling
- Alternate routing
- Ability of simultaneous sewing of various styles on one station
- Online networking of production
- Ability to link 2 systems of more and continue routing
- Ability to operate on more than 1 floor with one system
- Auto Balanced production process
- Online Real Time QC reports for customers

系统优势 效率提高  
More Efficiency

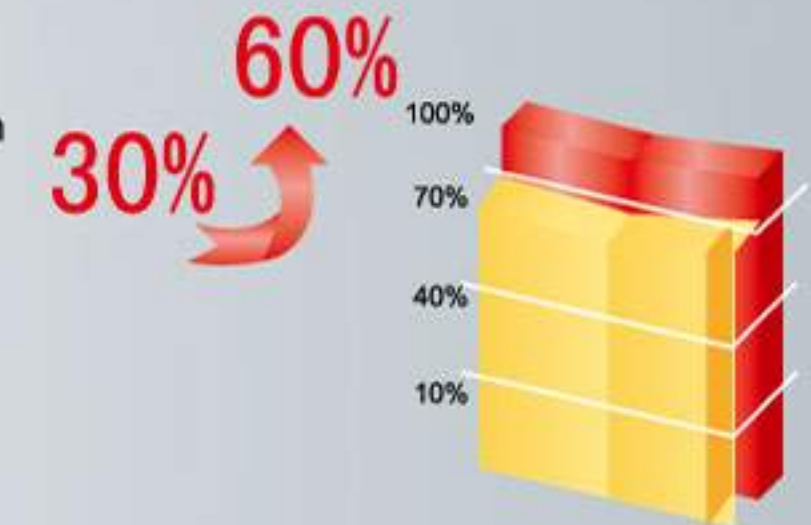

量身定制各种成衣生产线  
Customized System Layout

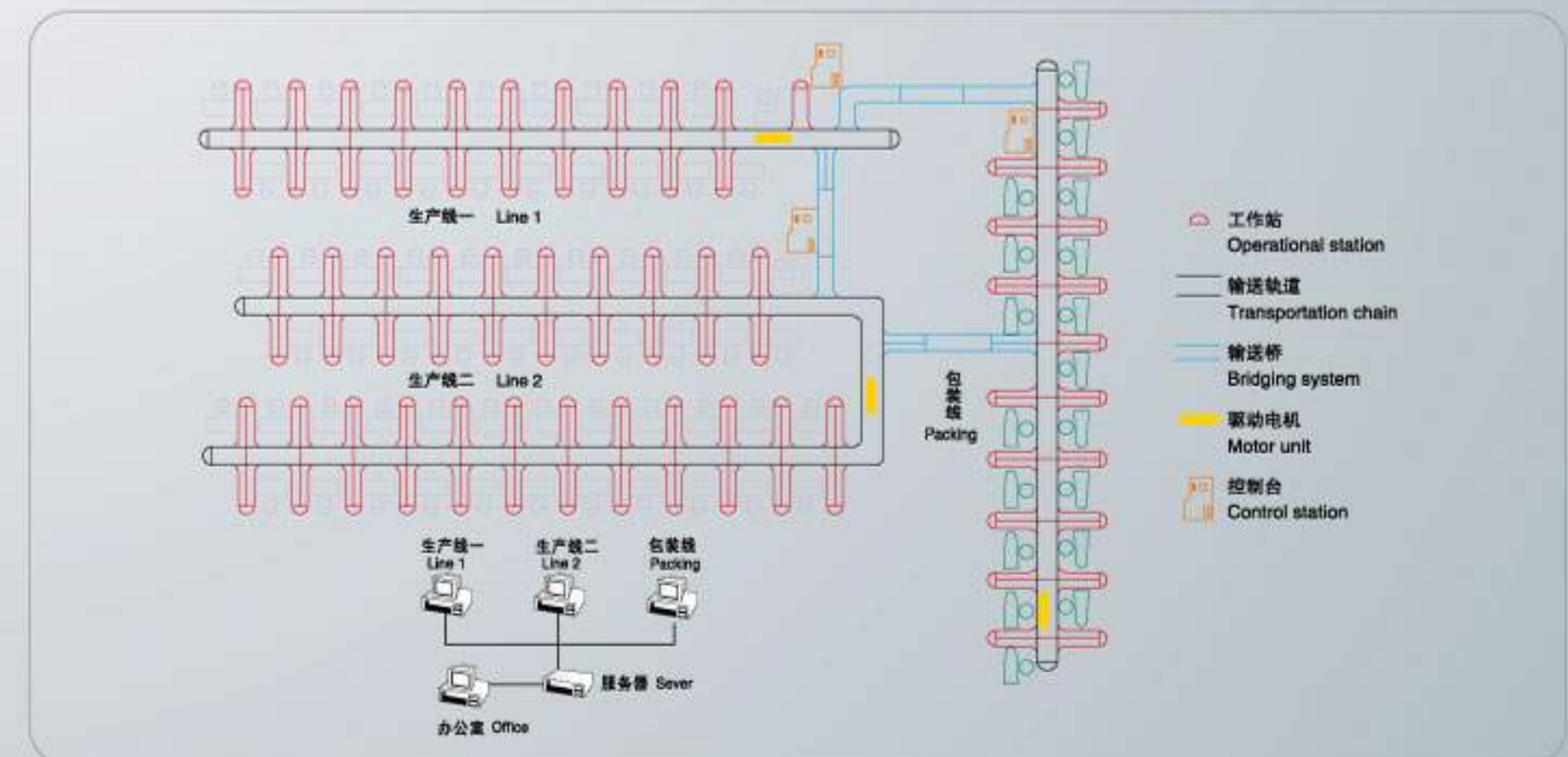



## 我们的产品 Our products

### 欧泰科®全自动制衣吊挂系统介绍

#### Euratex® Automatic Garment Hanging System Controbution

Euratex® 欧泰科®全自动吊挂系统集多年北美设计与使用经验于一身，其基本理念是将一整套衣服的裁片挂在衣架上，根据事先输入好的工序工段，自动送到下一道工序操作员手里。大幅度地减少搬运，捆绑，折叠，剪票据及重复的非产生时间。当生产员完成一个工序后，只需轻按控制按钮，吊挂系统就会自动地将衣架转送到下一个工序站。

Euratex® 欧泰科®电脑可以及时提供薪资报表，成本差异分析，每站实际生产现况，个别员工详细薪资资料，潜力产能之条件与分析，随机取样品管及检测。有了这些宝贵的报告，Euraxtex® 欧泰科®用户将具有强劲的市场竞争力，以满足现代服装市场多款式，短工期，高质量的要求。

Euratex® 欧泰科®全自动吊挂系统有完整的联系网络。Euraxtex® 欧泰科®电脑可以与用户，管理阶层，重要客户之间密切联系，以便了解生产状况。

Euratex® 欧泰科®全自动吊挂系统是一种管理系统，可以利用单件分工序工段流水式生产，以达成目标。

The basic concept of the Euraxtex® UPS(Unit Production System),a combination of North American design and many years of practical experience,is to bring the cut pieces of a single garment that are loaded into the hanger to the sewing machine operators at their work station with minimum handing for the operator.Upon competition of the individual's operation of a push button.This is all achieved by using a desk top comuper to direct the hangers.

The computer not only directs the hangers but also generates numerous management information reports designed to aid supervision in increasing productivity,reducing labor and overhead costs,maximizing available hours of manpower and utilization of equipment.Some of the reports generated include Payroll,Cost Variance,Real Time Display(RTD),Operator Daily Performance(ODP),Potential reports the users are sure to be more competitive and flexible in face of the ever changing and increasingly demanding market.

Euratex® UPS allow the user to network between Servers,office Manager and major customers to track production process.

The Euraxtex® UPS(Unit Production System)is a management system that uses Unit Production System to achieve its production targets.



### 世界独家双轨

#### 服装智能吊挂系统

Double rail Smart UPS

(Unit Production System)



### 链式智能

#### 服装吊挂系统

Chain smart UPS

(Unit Production System)



### 单轨智能

#### 服装吊挂系统

Monorail smart UPS

(Unit Production System)



## 我们生产什么 What do we make

### 服装悬挂仓储系统

Garment Hanging  
Storage System



### 手动服装仓储系统

Manual Transmitting System



### 电动服装悬挂仓储系统

Electric Transport System



### 智能立体仓储系统

Computerized Multiple-Level Storage System

# 世界独家双轨服装智能吊挂系统

## World's Unique Double rail Smart UPS(Unit Production System)

适用于针织服装、西装、牛仔、棉服、鞋帽、箱包、婴儿车、沙发、汽车内饰等较重产品。  
It is applicable for heavier products like knitwear, suits, denim clothes, hats and shoes, bags, baby carriages, sofa and automotive interior.

### • ES5000双轨吊挂系统

#### ES5000 Double-rail UPS



引进加拿大设计30年来不断改进升级。  
Introduced Canadian design and kept improving in the past 30 years.



全球首创双轨流水线，小概率掉衣架事件得到杜绝。  
The world's first double-rail assembly line putting an end to the small probability of hanger falling.



分体式吊架夹持裁片，输送到每一个工作站。  
The split-type hanger frame grips cutting pieces to each workstation.

## 首家通过上海质量技术监督局服装吊挂企业标准

### 标准代号Q/TFWO 1-2011

The first garment hanger manufacturer that meets the standards required by Shanghai Bureau of Quality and Technology Supervision Supervision.  
Standard Code Q/TFWO 1-2011



#### 员工终端显示器

##### Staff terminal

员工登陆控制，显示生产件数与生产效率  
It controls personnel's log-in, reveals production quantity and production efficiency, etc..

#### 专业衣架

##### Professional garment hanger

通内置RFID芯片，使每个衣架都有自己的身份识别。确保每件衣服的全程监控  
A RFID chip was placed in each garment hanger, which ensures to monitor each hanger in the process of production.

#### 单件放料结构

##### Single item adjust system

保证每次放入一个衣架进入工作区  
This device ensures that one hanger is loaded into the work area at one time.



#### 双轨结构

##### Double rail structure

主轨道为双轨道结构，形成封闭式轨道，保证衣架运行的稳定  
Double rail structured main rail forms a closed rail, guaranteeing stability of the operation of the system efficiency, etc..



#### 链条和导轨

##### Chain and Track



#### 旋转导轨进出站结构

##### In & Out Station

通过旋转导轨完成进出工位操作  
The hanger was track-controlled in &out Station by a special device.



#### 镶钢导轨结构

##### Steel-inlaid track structure

弯轨内镶有弹簧钢，保证可长时间高负荷运转  
Bent track is inlaid with spring steel to ensure long continuous operation under heavy load.

## 单轨智能服装吊挂系统

### Monorail Smart UPS(Unit Production System)

Euratex® 欧泰科®全自动吊挂系统是一种管理系统，可以利用单件分工序、工段流水式生产，已达成其生产目标。  
The Euratex UPS(Unit Production System)is a management system that uses Unit Production System to achieve its production targets.

Euratex® 欧泰科®全自动吊挂系统可以与用户、管理阶层、重要客户之间密切联系，以便了解生产状况  
Depending on the network Euratex UPS allow the user, office manager and customers share the information of production process.

### • E3000型标准吊挂系统 E3000 Standard UPS

适用于牛仔、针织、梭织、T恤等服饰。  
It is applicable for clothes like denim clothes, knitwear, tating wear and T shirts.



### • E5000主轨链条内藏式吊挂系统 E5000 UPS with a main rail having built-in chains

全新创新设计链条内藏式吊挂系统，稳重、美观、坚固、大气。  
The creatively designed built-in chain UPS is safe, beautiful, solid and impressive.



### • ED3000吊篮式吊挂系统 ED3000 Hanging Basket UPS

适用于文胸、内裤、手包、鞋帽等不适合吊架夹持的物品。  
It is applicable for items that can't be gripped by hanger frame like bras, underwear, handbags, hats and shoes.

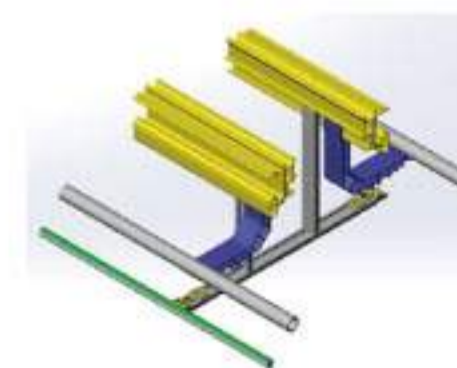

双层防护轨道  
Double-layer protective rail

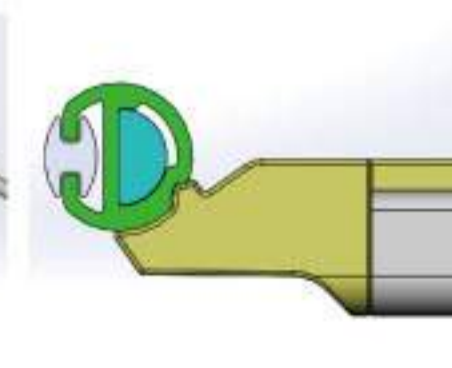

耐磨条  
Wear strip



全新设计小号篮子  
Newly designed small baskets



大号篮子（加侧袋）  
Large baskets (with side bags)

## 链式智能服装吊挂系统 Chain smart UPS(Unit Production System)

可控升降式链条系统,适用于西装、家纺、牛仔等产品。

The controllable lift chain system is applicable for products like suits, home textiles and denim clothes.

Euratex® 欧泰科®链式UPS系统提供了可控制和安全的单件流水线,使生产制造能力效率完整的提高,这是为了满足灵活、控制、可靠、安全和产量的需求而设计的。

The Euratex chain UPS system provides a controllable and safe one-piece flow assembly line, which greatly improves production capacity and efficiency. The system is designed to realize the requirements in terms of flexibility, control, reliability, safety and output.

### • EL3000链式吊挂系统 (高线) EL3000 Chain UPS (high line)

针对长袍、正装、羽绒服及窗帘、床单被套等家纺类产品,专业研发链式流水线。

It is applicable for robes, formal wear, down jackets and home textile products like curtains, bed sheets and quilt covers.



### • EL5000链式吊挂系统 (高线) EL5000 Chain UPS (high line)



针对被套、被芯等家纺类专业研发主轨内藏链条单轨链式吊挂系统。  
Develop the monorail chain UPS with the main chain having built-in chains for home textiles like quilt covers and quilt wadding.

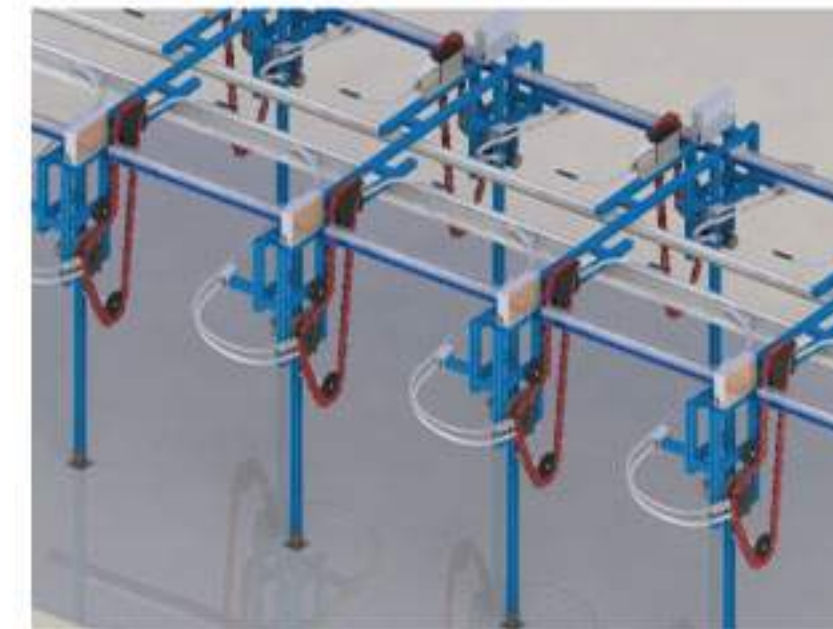

其特点为坚固、厚重、稳定、高承载力。  
It is solid, heavy and stable, and has good bearing capacity.



图为被芯加工现场。  
Quilt wadding processing site.





## 服装悬挂仓储系统介绍 Garment Hanging Storage System

从裁剪—缝制—品检—后整—仓储，在车间与车间，楼层与楼层，或者库房与库房之间桥接。立体服装仓储系统采用多层悬挂式存放衣服，可充分利用客户的厂房空间，系统分为手动仓储系统和智能化仓储系统两种类型，同时，还可以实现跨楼层运输，减少搬运，以满足客户不同需求。

Cutting-Sewing-QC-Packing-Warehouse. workshop to workshop, floor to floor, Warehouse to Warehouse. it can easily built bridges between warehouse. The garment storage system use multilayer hanging clothes storage, which can help customers to take advantage of their factory space. There are manual storage systems and intelligent storage systems. The system can transport across floors and warehouse to meet the different needs of customers.

### 手动服装仓储系统 Manual transmitting System



灵活的岔道设计，可满足不同的生产工艺要求，轻易实现缓存，返修及优先生产等需要，使整个生产流程有条不紊。

Clever design of the fork line can meet different production requirements. easily use as temporary storage. rework and optimized products, etc. makes the whole production process friendly.

### 电动服装悬挂仓储系统 Electric Transport System



## 智能立体仓储系统 Computerized Multiple-Level Storage System

适用于服装企业或服装配送企业的立体仓储管理，员工通过电脑监控系统能准确的查找衣物所在的仓位，并通过智能电脑控制系统运送到指定包装位，降低了工作强度，改善了工作环境，节省了工作时间。

It is applicable to the garment warehouse management Employees can easily to find the position of the desired clothes and send them to the demanded position by using the computer monitor. It improved the work environment and save the work time.





## 我们的优势与特点 Our advantages and features

### 优势 1 针对整厂的数字化快速制造解决方案

Advantage 1: The rapid digital manufacturing solution provided for the whole factory

包括样板房、唛架、工艺研发中心、裁剪、发外、验片、裁剪交接、车缝线内线外、后道、包装、品质、成品入库所有环节数字化。并结合我公司的智能裁剪、智能拉布系统,为服装企业提供一站式的解决方案。

All links have realized digitalization, including model houses, marker, technological research and development center, cutting, outsourcing, cut piece inspection, cutting delivery, outside and inside stitches, EOL processes, packaging, quality and storage of finished products. Together with our smart cutting and cloth spreading systems, we provide one-stop solutions to garment manufacturers.



### 优势 2 欧泰科吊挂系统的优势—吊挂控制、硬件生产

Advantage 2: The advantage of Euratex UPS—hanger control and hardware production

我们的吊挂系统,集多年北美设计与使用经验于一身。经过几代稳步发展,世界独家双轨结构、单轨结构、链式结构。现在我们已经发展到第三代。更先进的通讯技术—采用以太网传输。衣架芯片支持低频125K、高频13.56M、IC芯片、控制系统更加稳定、安全。

Our unit production systems adopt the design and use experience of the North America. Through generations of stable development, we develop unique double-rail, monorail and chain structures. Now, we have developed the third generation of systems. We adopt advanced communication technology, using Ethernet for transmission. The hanger chips are IC chips which support the low frequency of 125K and the high frequency of 13.56M. The control system becomes more stable and safer.

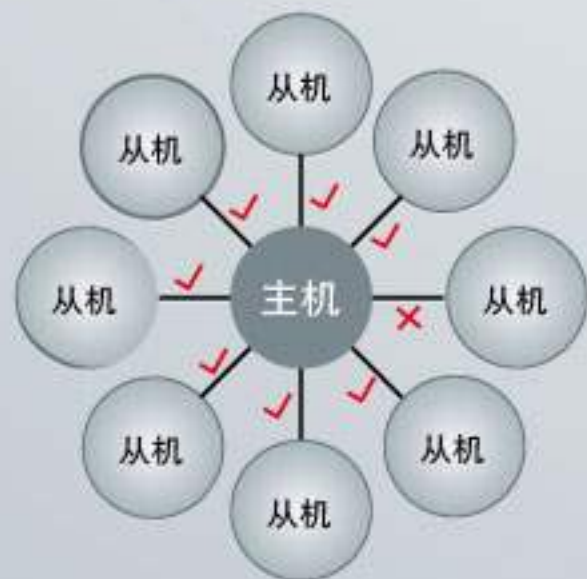
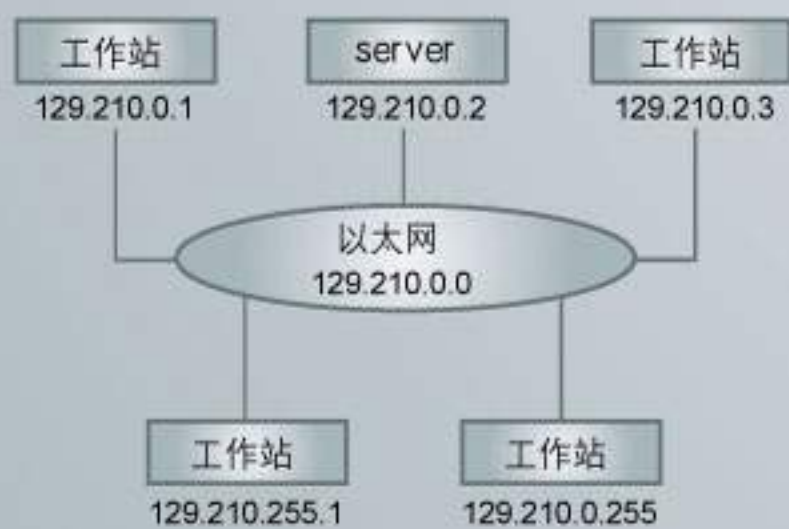

- 能自动根据定单数量及用户设定的工艺流程,分配各工序所需要安排的工作站数量,达到平衡生产,提高生产效率。
- 能自动根据员工效率来自动分配衣架。
- 故障容错能力强:如果其中一个站发生故障不影响其他站,整个系统仍然正常工作。
- 对有质量问题的,可进行返工。系统每个工作站都可以做返工站,当员工发现衣服有质量问题,可以把衣服送到出错工作站去。返工完后,衣服会自动到下个未做工序。在返工过程中,系统自动记录谁返工、返工工序以及返工次数,管理者可根据这些数据对员工素质或机器故障进行分析。
- 低气压中断链条:流水线上的基本运作设备是气动元件,足够和稳定的气压是关键条件。产生不稳定的气压通常是由于空压机的压力不够或气管漏气,会导致衣架的进出站不正常。对此,系统能自动识别气压是否正常,当气压达不到系统要求时,系统自动报警,并停止运转。
- 衣架自动回归:当系统在停电等异常情况下,轨道上衣架不能正常进站。衣架在系统重新启动后,能重新自动定位到工艺流程所指定的路线。
- 可以进行任何点对点的线路安排,不受工作站先后顺序的影响。
- 服装跟踪系统可对每件衣物制造过程中进行跟踪,能查找每道工序是谁做的,哪个站做的,什么时间做的等信息。新开发的捆绑条码功能,可对离开衣架的,如已经到后整或水洗后的衣服,依然能查出上面的信息。
- 系统具备自动诊断功能,可诊断气动元件是否工作正常,有利于客户工厂人员日常维护。
- 可查找流水线中每道工序生产进度并通过LED条屏显示成品量。
- 可实时显示每个员工的工作效率。
- 对裁片有问题,无法继续加工的衣服,可以把该问题裁片拿下,去其他部门配片,配好后,重新拿个新衣架,继续自动做未完成的工序。
- 可以查找到轨道上每件衣服从哪个站出来,将去哪个站。
- 可以控制下衣站的衣架回到任意指定的工作站,避免衣架在轨道上霸占杆位的时间过长,影响其他站的衣服出站。
- 一个衣架上挂多件衣服,生产数量上自动计算。对生产时间短的工序,可以减少员工按按钮的时间。
- 对IE部门编辑好的工艺流程,可以通过一个带有工序名称等信息的EXCEL文件倒入数据库,可以避免手工重复输入的工作。
- 可同时进行多款式生产,一个站可以同时做多个工序。
- 可对客户提出的有价值的需求进行个性化定制,与客户原有的ERP、FMIS、条码数据采集等系统进行无缝连接,数据共享。



自动分配衣架  
Automatically distribute hangers



真正的智能返工  
Veritable smart garment remade process



衣架自动回归  
Automatic return of hangers

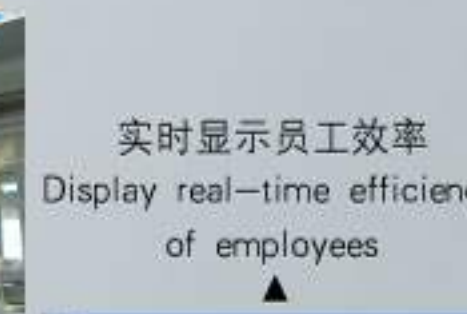

实时显示员工效率  
Display real-time efficiency of employees



### 优势 3 创新的SOP作业指导系统

#### Advantage 3: Innovative SOP Guide System

帮助企业实现电子作业指导。系统自动把工艺的处理方式方法，可具体到每一种款式每道工序的作业指导描述流程自动显示在每个RFID终端，让员工清楚的理解并彻底的执行。由此提高员工的工作效率，减少质量事故，质量隐患。

Help enterprises realize the guide of electronic operation. The system can automatically apply processing methods to every style and every process, and automatically display the description of procedures on each RFID terminal so as to enable employees to clearly understand and thoroughly implement the procedures. The system can improve the working efficiency of employees, and reduce quality accidents and hidden quality problems.



### 优势 4 创新的电子工票硬件无线平板终端

#### Advantage 4: Innovative Electronic Workticket Hardware Wireless Tablet Terminal

创新的电子工票硬件无线平板终端。

Innovative Electronic Work ticket Hardware Wireless Tablet Terminal.

### 优势 5 同一套数据库，一条龙数字化体系

#### Advantage 5: The same database, A one-stop digital system

从自动裁剪数据，拉布机数据，电子工票与吊挂数据建立在同一套数据库，为金红棉提供国内唯一一家完全自主研发的数字化整体方案；并提供数据接口中心，与ERP及电子商务系统提供标准接口，详细参考ERP对接说明；同一套系统中可以反馈线内线外的数据。

The automatic cutting data, the data of cloth spreading machine, the workticket data and the UPS data are integrated into the same database. We have provided the only independently developed integrated digital solution in China for Foshan Jinhongmian Clothing Co., Ltd. We also provide the data interface center which together with the ERP and the E-commerce system provides standard interface. Refer to the ERP description for detailed information.

The same system can feed back the data inside and outside the system.

### 车间现场实时状态数据

#### Real-time status data of workshop sites



每个员工的详细效能

黄色表示该组别有员工在工作，无颜色表示该组无员工在工作

多少个员工在工作，空闲了几台设备

员工在岗位上，会显示其照片，显示在做哪道工序，员工效率低时，下面的字红色显示，不在岗位时，显示衣车图标

### 车间现场进度瓶颈监控

#### Schedule bottleneck monitoring of workshop sites

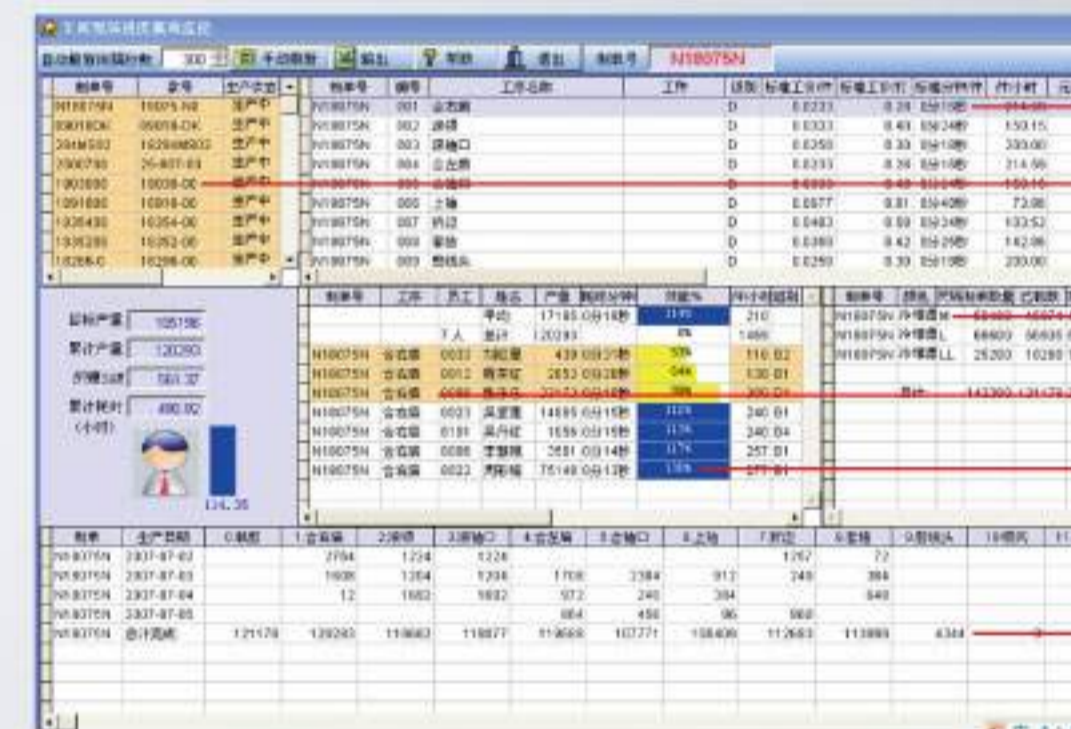

每道工序标准工时，工价

显示哪些订单正在生产

按颜色、尺码统计进度

IE人员可评估工时工价合理并及时推广改进

工序进度

图形化显示效能%  
效能高蓝色显示  
效能≥50% 黄色显示  
效能<50% 红色显示  
评估标准工时是否合理

### 车间产能绩效

#### Productivity performance of workshops

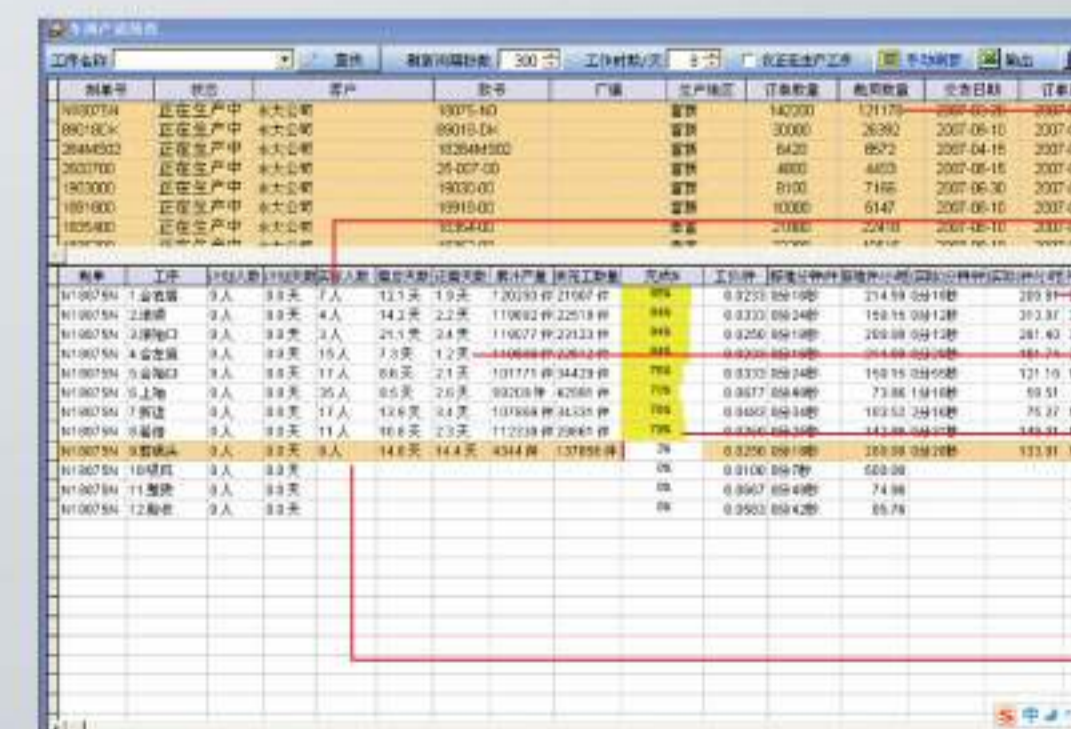

每个订单的信息

安排的人数

实际平均产量

还需天数

图形化显示完成率  
完成绿色显示  
完成≥50% 黄色显示  
完成<50% 红色显示

带黄色提示，系统自动找出瓶颈工序

### 自动预警平台 Automatic early-warning platform



### 员工工资对比分析 Contrastive analysis of employees' salaries

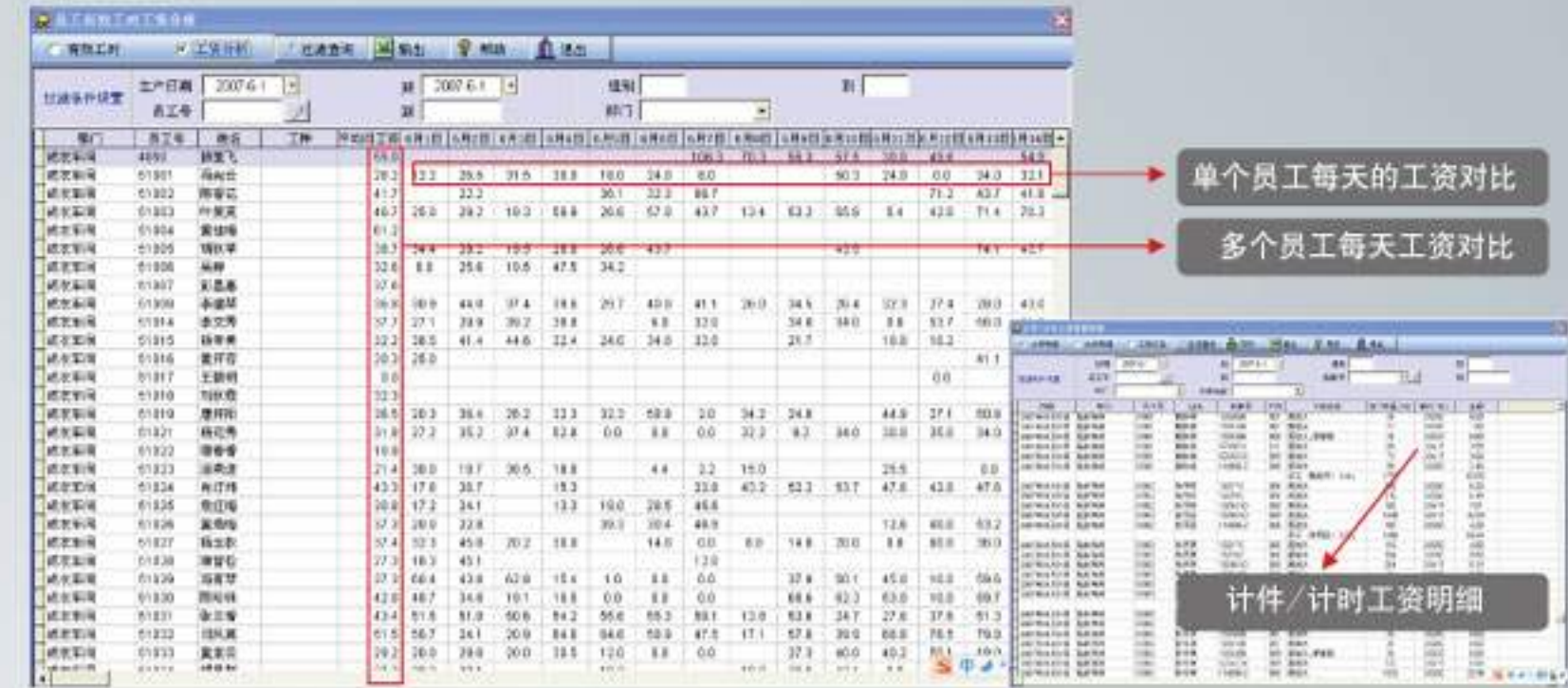

### 生产效能分析 Analysis of production efficiency

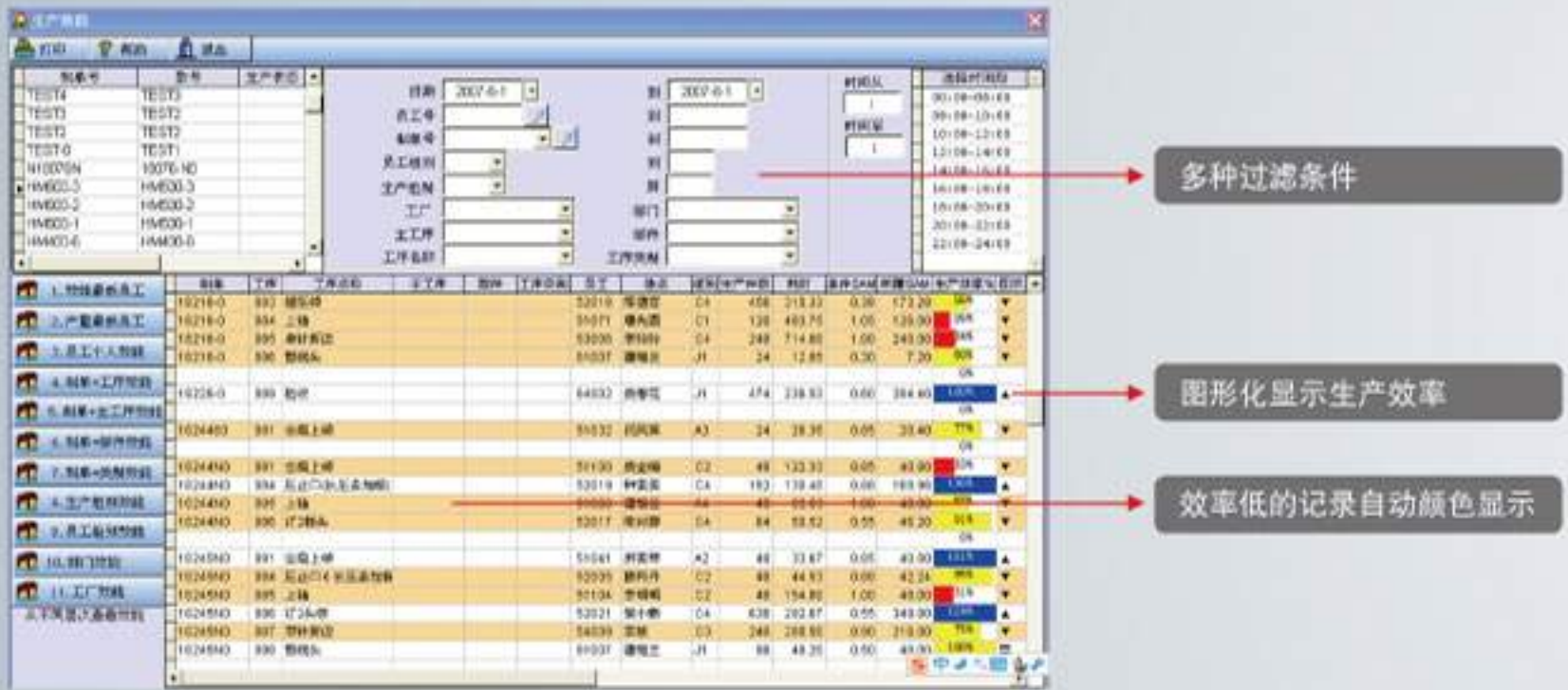

### 次品管理 Management of defective products

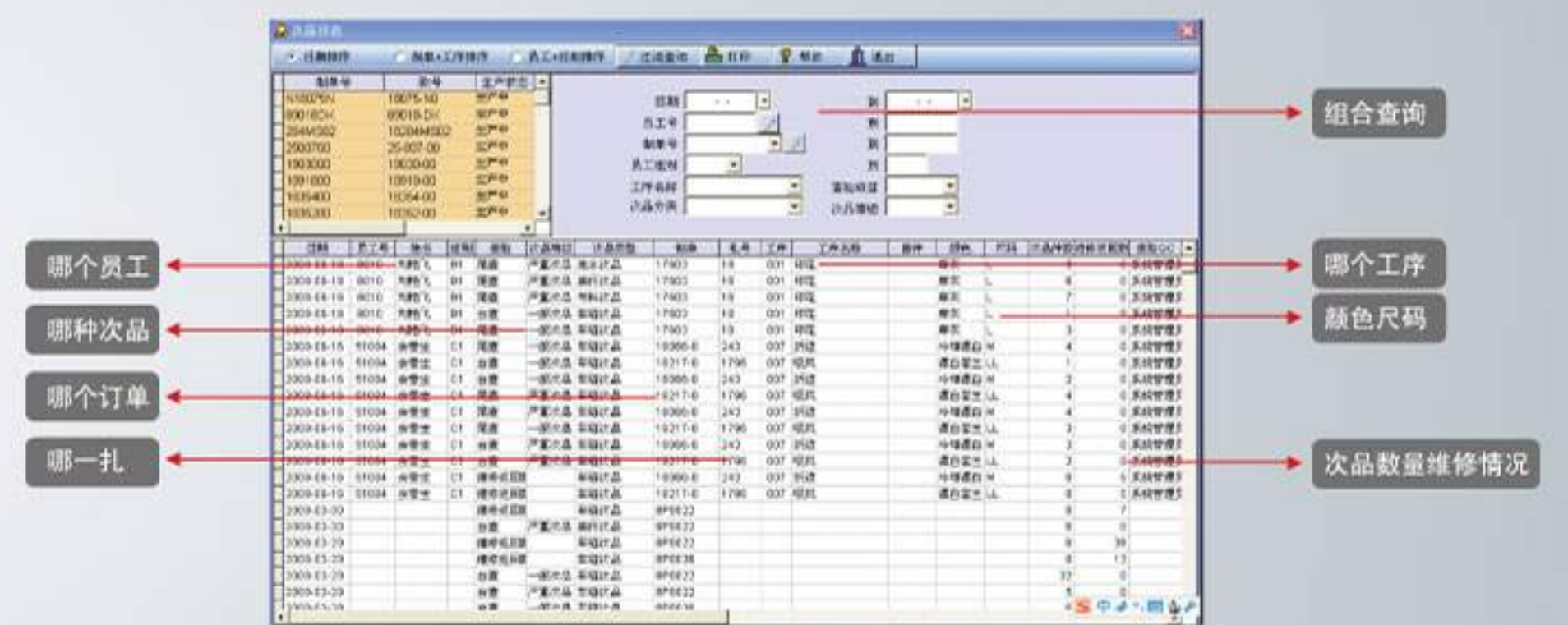

### 在制品进度 Schedule of work-in-process



### 质量品质信息 Quality information



### 员工自助查询产量 Self-service inquiry of output for employees

姓名	款号	工序	工序名称	生产日期	产量(打数)
腾和明	25-005-N0	7	套结*2	2007年06月18日	2打
腾和明	52-052-DK	6	前袖套结	2007年06月18日	26打
腾和明	52-053-DK	6	前袖套结	2007年06月18日	283打1件
腾和明	18353-00	7	套结*3	2007年06月17日	4打
腾和明	18354-00	7	套结*2	2007年06月17日	8打
腾和明	25-005-N0	7	套结*2	2007年06月17日	2打
腾和明	52-052-DK	6	前袖套结	2007年06月17日	154打6件
腾和明	52-053-DK	6	前袖套结	2007年06月17日	173打7件
腾和明	18034-00	7	套结*2	2007年06月16日	2打
腾和明	18353-00	7	套结*3	2007年06月16日	18打
腾和明	18354-00	7	套结*2	2007年06月16日	18打
腾和明	25-005-N0	7	套结*2	2007年06月16日	2打
腾和明	52-052-DK	6	前袖套结	2007年06月16日	108打
腾和明	52-053-DK	6	前袖套结	2007年06月16日	124打

## 我们的产品研发

Our product research and development

想客户所想，从心出发，用心思考的研发理念是欧泰科®保持品牌领先的要诀

The research and development concept of putting ourselves in customers' position is our main knack to keep Euratex® in a leading position.



每一个产品，即使是一个小小的零部件都要经过我们的精心设计，这就是欧泰科®至始至终追求的一种理念与精神，精益求精，不断探索，与世界顶级研发水平接轨，结合本地用户标准不断完善改进。我们将成为最专业、最优化、最尖端的服装智能设备品牌。

欧泰科® 每年投入大量人力物力来针对新产品、新工艺的研发，公司历年获得的专利包括：旋转导轨、推杆机构、料挂轮无油轴承、读卡器、弧形导轨、料挂轮、双轨道机构、输送链条涨紧棘轮机构、变向轨道、双向变轨机构、防卡死推杆机构、输送装置等。

Every product, even a small part, is elaborately designed. This is the concept and spirit that Euratex® has been pursuing. We keep improving and exploring, gear to the top-level R&D level in the world, and keep improving based on the standards of local users. We will become the best smart garment equipment brand.

Euratex® puts lots of manpower and material resources in developing new products and technologies every year. The company has taken out patents on: the rotatory guide rail, the push rod mechanism, the oilless bearing of material hanger gear, the card reader, the arc-shaped guide rail, the material hanger gear, the double-rail mechanism, the transport chain tensioning ratchet mechanism, the turning guide rail, the two-way rail transfer mechanism, the anti-lock push rod mechanism and the transport device.

Help customers in production training and improve production efficiency.

## 我们的培训

Our training

帮助生产培训，提升生产效能

Help production training and improve production efficiency

Euratex® 欧泰科® 培训目的

- 帮助工厂构建IE管理体系
- 帮助工厂对生产流水线的管理培训
- 帮助工厂建立6S现场管理

The purposes of Euratex® training

- Help factories build IE management systems
- Help factories in management training of production lines
- Help factories build the 6S field management system



6S管理目的

Purposes of 6S management

- 提供一个舒适的工作环境  
Provide a comfortable working environment
- 提供一个安全的工作场所  
Provide a safe working site
- 提高员工的工作情绪  
Improve the morale employees
- 提高现场的生产效率  
Improve the field working efficiency
- 稳定产品的品质水准  
Stabilize the quality level of products
- 增加设备的使用寿命  
Extend the service life of equipment
- 塑造良好的公司形象  
Shape a good corporate image
- 创造一个能让亲友参观的厂房  
Create a factory for friends and relatives of employees to visit

6S管理效果

Effects of 6S Management

- 工序细分  
Subdivide production processes
- 品质明确  
Definite quality
- 产能直观  
Visual production capacity
- 便于控制  
Easy to control
- 时时监控  
Real-time monitoring
- 减少搬运  
Reduce transport
- 环境整洁  
Clean environment

## 我们的售后服务 Our after-sales service

### • 客户投诉管理 Customer complaint management



### • 客户主动回访 Re-visit proposal

温馨短信：每周一次  
message: once a week  
电话关怀：每月一次  
Telephone: Once a month  
上门服务：每季度一次  
Visit: once a quarter

### • 400快速响应 Rapid response by 400-hotline



### • 线上线下服务平台 On-line and off-line service platform



### • 完整的售后服务体系 Complete after-sales service system



目前全国有**11**家专业服务网络

2011-2014在建**100**家4S店

全国**30**多个省市及直辖市设有分公司或代理商，拥有**1000**多家客户

欧泰科® 产品已经远销印尼、柬埔寨、泰国等海外国家

欧泰科® 为客户提供融资租赁服务，零首付、零利息、分期付款

Now we have 11 professional service networks nationwide

From 2011 to 2014, we have built 100 4S stores.

We have branches or agencies in more than 30 provinces and municipalities, and more than 1,000 customers.

Euratex® products have been exported to overseas counties like Indonesia, Cambodia and Thailand.

Euratex® provides customers with financing and leasing services characterized by zero down payment, zero interest and payment by installments.



## 我们的客户

### After-sales service

### 应用实例

#### Customer complain management



#### 武汉爱帝针纺实业有限公司

Lovegod High-level Dress and Adornments Co., Ltd.

生产类型: 针织内衣, 运动卫衣等 工位: 16条线

Product types: knit underwear, sports sweaters, etc. Production lines: 16



#### 河南万家欢乐纺织服装有限公司

Henan Wanjiale Textiles and Garments Co., Ltd.

生产类型: 西服 工位: 4条线

Product Type: suites Production lines: 4



#### 惠州恒胜制衣厂

Huizhou Hengsheng Garment Factory

产类型: 女士内衣 工位: 3条

Product type: women's underwear Production lines: 3



#### 东莞市以纯集团有限公司

Dongguan Yishion Group Co., LTD

产品类型: 休闲装, 牛仔 吊挂生产线: 9条线

Product types: casual wear, pajamas UPS production lines: 9



#### 山东海之杰纺织有限公司

Shandong Lawrance Textile Co., LTD

产品类型: 休闲服饰, 睡衣, 工作服, 内衣, 童装, 婴儿装等

吊挂生产线: 10条线

Product types: casual wear, pajamas, work clothes, underwear, children's garments and babies' clothes. UPS production lines: 10



#### 周口庄吉服装有限公司

Zhoukou Judger Garment Co., LTD

产品类型: 西服, 羽绒服, 牛仔, 制服等 吊挂生产线: 32条线

Product types: suits, down jackets, denim clothes, uniforms, etc.

UPS production lines: 32



#### 上海美特斯邦威服饰股份有限公司

Shanghai Metersbonwe Garments Co., LTD

产品类型: 休闲装, 牛仔, 童装等 吊挂生产线: 10条

Product types: casual wear, denim clothes, babies' clothes, etc.

UPS production lines: 10

2009年9月10日, 全国人大常委会主任委员等领导到李宁(荆门)工业园—湖北动能体育用品有限公司裁床车间, 吊挂车间进行实地考察, 并认真观看了全自动电脑裁剪机、吊挂生产线系统工作的情况, 荆门市委书记傅德辉书记介绍说: “这套设施系统到目前为止是中国最好最快的吊挂设施, 它需要团队作战, 生产技术要比较平均, 就像我们所有的供应商一样, 要紧密配合, 要有一套好的供应链。”

中合服饰有限公司是JEEP的生产厂家, 目前已经拥有6条双轨服饰智能吊挂流水线, 在使用了服饰吊挂系统之后, 刘总这样说: “可控制的安全的产品单件流水线改变了包流的生产方式, 在生产中更短的时间内可以看到成品, 可及时发现问题, 及时改正, 避免了大批量的成品完成后集体返工情况的出现, 企业的整体环境得到了很好的改善, 减少浮余工艺辅助动作, 生产效率有了很大的提高。”

波司登生产工厂神游制衣的张主任说: “在使用欧泰科智能服装吊挂系统以后, 由原来每个车间每天生产110件羽绒服到每天生产200件”, 生产效率大幅提高, 管理人员只需看电子看板就可以统筹整个工厂的生产情况, 自动统计核算员工工资, 避免错算漏算, 人员通过网络安排生产工序, 提高了管理效率, 电脑智能平衡工序间产能分配, 减少了待工待料现象, 工厂整体效益大幅提高。



立信制衣有限公司是阿依莲的生产厂家, 针对产品款式多换款快的特点, 服装智能吊挂系统与生产达到了最佳配合, 分段式工序生产, 同一生产线可同时生产多种款式, 减少换款时间, 最大程度的缩短了订单的生产周期, 满足市场多款式, 小批量, 高质量的要求, 同时, 企业形象也有很大的提高, 员工从2009年的300多名, 到现在的1000多人, 工人薪资, 生产效益都有提高, 公司的阿依莲工业园正在建设中。

Euratex服装智能吊挂系统, 广泛运用于针织服装, 西装, 牛仔, 棉服, 鞋帽, 箱包, 婴儿车等领域。光大集团是首家将智能服装吊挂系统运用于帽子生产的厂家。Riorex是该集团生产的品牌之一, 运用吊挂系统后, 整厂环境干净整洁, 避免了浅色面料在生产中沾上污渍, 减少了后整工序工时, 成品率大幅提高, 形成了良好的生产气氛, 员工薪资及生产积极性提高的同时, 也提高了企业的竞争力。

# 欧泰科服务过的客户 Customers of Euratex®



# 我们的荣誉 Our Honor

Euratex® 欧泰科® 产品拥有多项自主知识产权。  
The copyright & o Patent of Euratex products.

